

Trimmers

Popular cutters - ideal for trimming formica and laminates

TCT 90° Bearing Guide Edge Trimmer

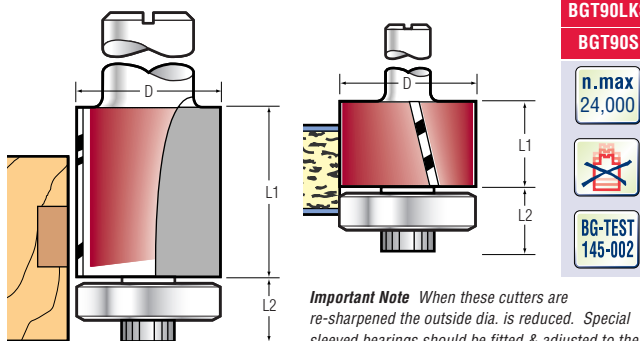

BGT90LKS

BGT90S

n.max
24,000



BG-TEST
145-002

Important Note When these cutters are re-sharpened the outside dia. is reduced. Special sleeved bearings should be fitted & adjusted to the cutter dia. Contact us for specialist information.

The longer life trimmer. Extremely popular cutters for cutting formica and laminates. **For trimming plastic laminates.** The most complete range of formica trimmers available in any cutter range. **S** denotes shearcut. Downcut action gives cleaner finish. For fine laminates always use BGT90S. BGT90LKS range is ideal for trimming thicker materials using the bearing for guiding.

Order Ref. No.	Dmm	L1mm	L2mm	Shank						
				6mm	1/4"	8mm	3/8"	10mm	12mm	1/2"
BGT90	18	12	-	£25.00	£25.00	£25.00	£25.00	-	-	-
BGT90S	18	12	-	£26.00	£26.00	£26.00	£26.00	-	-	-
BGT90SLP	18	12	8.5	£29.00	-	-	-	-	-	-
BGT90LKS	18	25	-	£32.00	£32.00	£32.00	£32.00	£32.00	£32.00	£34.00
BGT90LKSPL	18	25	8.5	£33.00	-	-	-	-	-	-
BGT90LK1	18	37	-	-	£44.00	£44.00	-	£44.00	£44.00	-
BGT90LK2	18	50	-	-	£52.00	-	£52.00	£52.00	-	-
B18	Replacement Bearing									£7.00

TCT 89° Bearing Guide Edge Trimmer

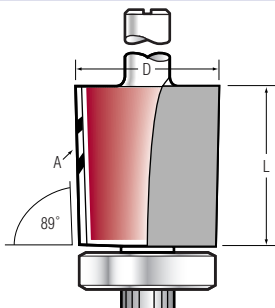

BGT89LK

n.max
24,000



BG-TEST
145-002

Order Ref. No.	Dmm	Lmm	A	Shank	
				8mm	12mm
BGT89LK	19	25	89°	£37.00	-
B18	Replacement Bearing				£7.00

TCT 90° Bearing Guide Triple Flute Trimmer

For short production runs only.

Triple flute cutters designed for fine finish. Double B127 bearings prevent the tendency to wander on heavier cuts. The small diameter coupled with three flutes and hand fed on a portable router will cause extreme heat build up. For longer production runs use a larger diameter cutter like our BGT90S with shear angle.

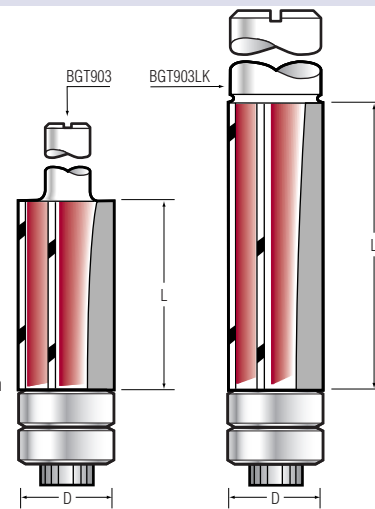

BGT903

n.max
24,000



BG-TEST
145-002

For daily use and longer production runs use BGT90, BGT90S, BGT90LK, BGT90LK1 and BGT90LK2. These cutters have larger diameter bearings and a unique fibre shield which prevents heat build up.

Titman Tip Top bearing option available - see pg. 102 - item XC076 + optional accessories pg. 101 - Contact sales for details.

Order Ref. No.	Dmm	Lmm	A	Shank					
				6mm	1/4"	8mm	12mm	1/2"	
BGT903-20	12.7	20	90°	-	£25.00	-	-	£25.00	
BGT903	12.7	25	90°	£25.00	£25.00	£25.00	-	£25.00	
BGT903LK	12.7	38	90°	-	-	-	£45.00	£45.00	
B127	Replacement Bearing								£6.00

TCT 90° Double Guided Trimmer

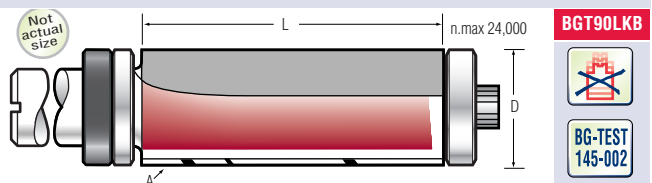

BGT90LKB



BG-TEST
145-002

This cutter has a bearing mounted on the shank as well as on the bottom pivot.

Order Ref. No.	Dmm	Lmm	A	Shank	
				12mm	1/2"
BGT90LKDB	19	25	90°	£49.00	£49.00
BGT90LK2DB	19	50	90°	£55.00	£55.00
B19	Replacement Bearing				£7.00
B1912	Replacement Bearing				£7.00

TCT 90° Bearing Guide Double Trim

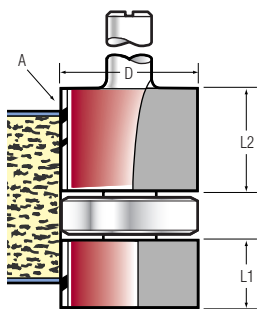

D/BGT90

n. max
24,000



BG-TEST
145-002

Unique in that this cutter will trim the top and bottom edges of a panel simultaneously, whilst the centrally mounted bearing follows the profile.

Order Ref. No.	Dmm	L1 & L2mm	A	TCT Shank				
				6mm	1/4"	8mm	3/8"	1/2"
D/BGT90	18	10 & 14	90°	£45.00	£45.00	£45.00	£45.00	£45.00
Replacement Tip Versions								12mm 1/2"
D/BGT90RT	25	12 & 12	90°	-	£94.00	£94.00	-	-
D/BGT90RT	25	12 & 20	90°	-	-	-	£94.00	£94.00
B18	Replacement Bearing							£7.00
B25	Replacement Bearing for RT version							£7.00
L12	Replacement Tip							£3.00
L20	Replacement Tip							£4.00
M4 x 6	Torx screw							£5.00

TCT 90° Internal Bearing Guide Edge Trimmer - Small Diameters

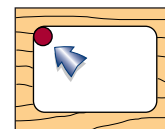
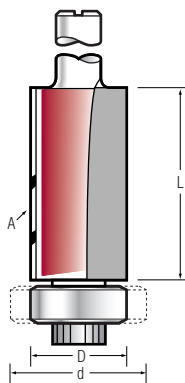

IBGT90LK-19

n. max
24,000



BG-TEST
145-002

Suitable for trimming apertures and holes for the caravan and mobile home industry. Smaller diameter bearings 6.3 and 9.5mm are prone to heat build up – we recommend for normal trimming and long production runs a cutter with a B18 bearing, ie. BGT90.

*Special grade carbide for trimming aluminium.

IBGT90LK-19 is designed for overlay work (19mm dia. bearing)

Titman Tip

Top bearing option available - see page 97 - item XC066 + optional accessories - see page 101. Contact sales dept.

Order Ref. No.	D	Bearing dia. mm	L	A	TCT Shank					
					6mm	1/4"	8mm	3/8"	12mm	1/2"
IBGT63	1/4"	6.3	1/2"	90°	£22.00	£17.00	-	-	-	-
IBGT63LK	1/4"	6.3	1"	90°	£23.00	£18.00	-	-	-	-
IBGT38	3/8"	9.5	1/2"	90°	£24.00	£18.00	£24.00	-	-	-
IBGT38LK	3/8"	9.5	1"	90°	£26.00	£19.00	£19.00	-	-	£22.00
IBGT90	1/2"	12.7	5/8"	90°	£25.00	£22.00	£25.00	£22.00	-	£22.00
IBGT90LK	1/2"	12.7	1"	90°	£22.00	£22.00	£22.00	£22.00	-	£22.00
IBGT90LK1	1/2"	12.7	1.1/2"	90°	-	-	£42.00	-	£42.00	£42.00
IBGT90LK2	1/2"	12.7	2"	90°	-	-	-	-	£53.00	£53.00
SIBGT90LK*	1/2"	12.7	1"	90°	-	£24.00	-	-	-	£24.00
IBGT90LK-19	1/2"	19	1"	90°	-	£27.00	-	-	-	-
B6.3	Replacement Bearing 6.3mm							£9.00		
B127	Replacement Bearing 12.7mm							£6.00		
B19	Replacement Bearing 19mm							£7.00		
B375	Replacement Bearing 9.5mm							£9.00		

TCT 90° Trimmer and V Groove

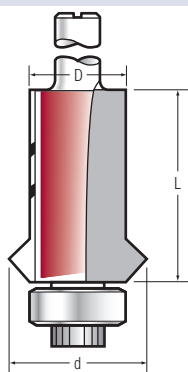

BGT90V

n. max
24,000



BG-TEST
145-002

Two flute cutter for trimming of laminates and solid lipping.

V groove to hide glue line.

Use B14 bearing to reduce V-groove depth.

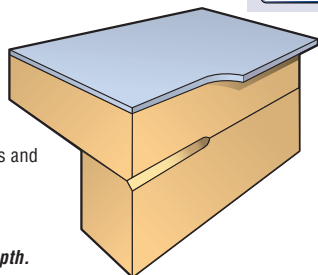

Order Ref. No.	Dmm	d mm	Lmm	A°	TCT Shank			
					1/4"	8mm	12mm	1/2"
BGT90V	16	12.7	25.4	90°	£25.00	£25.00	£25.00	£25.00
B127	Replacement Bearing							£6.00
B14	Replacement Bearing							£7.00

TCT Bearing Guide Edge Trimmers

For bevelling and trimming plastic laminates.

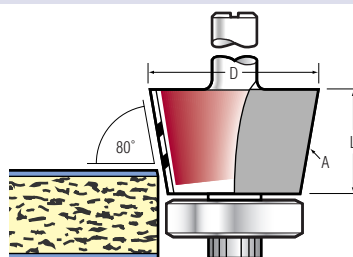

BGT80

n. max
24,000



BG-TEST
145-002

Order Ref. No.	Dmm	Lmm	A	TCT Shank				
				6mm	1/4"	8mm	3/8"	
BGT75	23	15	75°	£37.00	-	£37.00	-	
BGT80	20	14	80°	£32.00	£32.00	£32.00	£32.00	
B16	Replacement Bearing							£7.00

For bevelling and trimming plastic laminates.

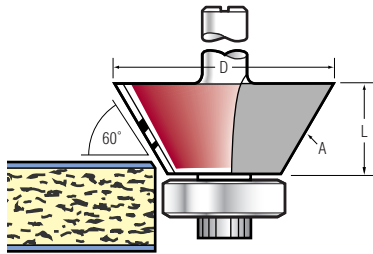

BGT60

n.max
24,000



BG-TEST
145-002

Order Ref. No.	Dmm	Lmm	A	Shank			
				6mm	1/4"	8mm	3/8"
BGT60	28	12	60°	£32.00	£32.00	£32.00	£32.00
B16	Replacement Bearing			£7.00			

For bevelling and trimming plastic laminates.

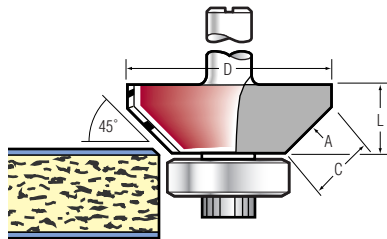

BGT45

n.max
24,000



BG-TEST
145-002

Order Ref. No.	Dmm	Lmm	Cmm	A	Shank			
					6mm	1/4"	8mm	3/8"
BGT45	27	9	9	45°	£32.00	£32.00	£32.00	£32.00
B16	Replacement Bearing			£7.00				

BGT4590
A two-in-one cutter for trimming plastic laminates at both 45° and 90°.

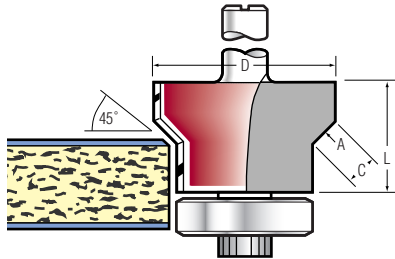

BGT45/90

n.max
24,000



BG-TEST
145-002

Order Ref. No.	Dmm	Lmm	Cmm	A	Shank		
					6mm	1/4"	8mm
BGT45/90	24	15	4	45°	£35.00	£35.00	£35.00
B18	Replacement Bearing			£7.00			

For bevelling and trimming plastic laminate.

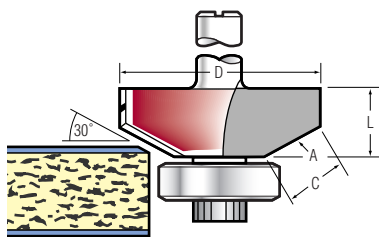

BGT30

n.max
24,000



BG-TEST
145-002

Order Ref. No.	Dmm	Lmm	Cmm	A	Shank		
					6mm	1/4"	8mm
BGT30	27	9	9	30°	£32.00	£32.00	£32.00
B16	Replacement Bearing			£7.00			

TCT Bearing Guide Bevel Trimmer

A self guided trimmer with a gap between bearing and cutter to prevent adhesive build-up.

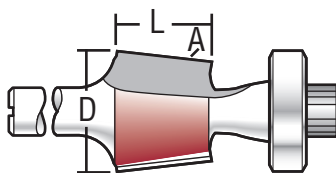

BGT A82

n.max
24,000



BG-TEST
145-002

Order Ref. No.	Dmm	Lmm	A	Shank
				1/4"
BGT A82	15	12	82°	£22.00
B127	Replacement Bearing			£6.00

TCT Light Duty Trimmer – Three wing

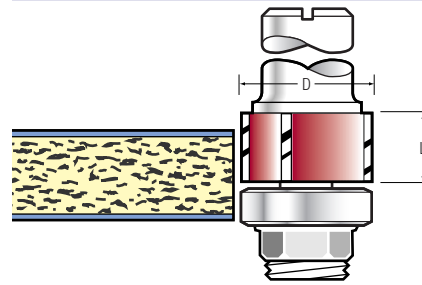

LDT10

n.max
12,000



BG-TEST
145-002

These trimmers are available with 90°, 80°, 45°, 30° and 22° angles. For further information please contact our sales department.

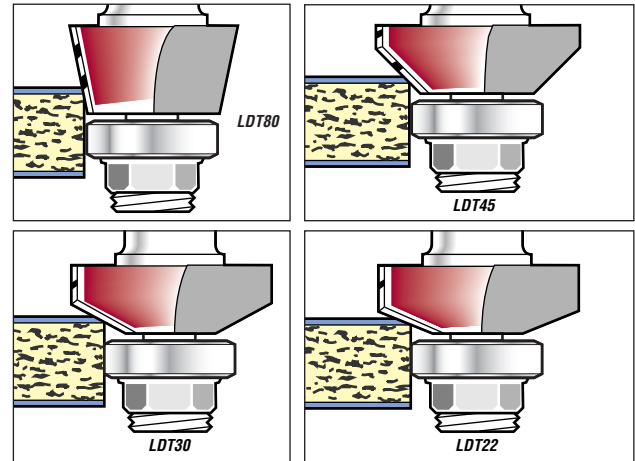

Order Ref. No.	Dmm	Lmm	Bore Dia. mm				Shank	
			6mm	1/4"	8mm	3/8"	1/2"	
LDT10	16	10	6.3	£45.00	£45.00	£45.00	£45.00	
(LDT10 is supplied complete with 90° trimmer and arbor)								
LDT90	Replacement Trimmer 90°			£28.00				
LDT80	Replacement Trimmer 80°			£28.00				
LDT45	Replacement Trimmer 45°			£28.00				
LDT30	Replacement Trimmer 30°			£28.00				
LDT22	Replacement Trimmer 22°			£28.00				
B16	Replacement Bearing			£16.00				
LDTA NB	No Bearing			£11.00	£11.00	£11.00	£11.00	£14.00
LDTA	Arbor with Bearing B16			£17.00	£17.00	£17.00	£17.00	£19.00

TCT 90° Solid End Trimmers

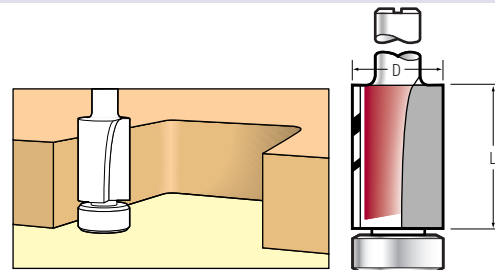

SET1214

n.max
24,000



BG-TEST
145-002

With solid end guide for heavy duty trimming on internal sections. Used in caravan manufacture. Solid guide is removable for easier sharpening.

Order Ref. No.	Dmm	Lmm	Shank	
			1/4"	3/8"
SET1214	1/2"	3/4"	£24.00	–
SET1238	1/2"	3/4"	–	£24.00
SB127	Solid end Bearing		£2.00	

RT 90° Guide Trimmers

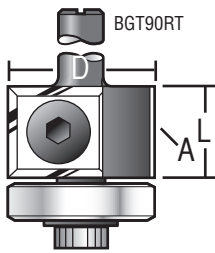

Replacement Tip Guide Trimmer with bearing guide and Replacement Solid Tungsten Turnover Knives. **L12 tip has four cutting edges.** Safe for portable machines of 800 watts and over.

BGT90RT

n.max
24,000



Order Ref. No.	Dmm	Lmm	A	Tip	Shank					
					6mm	1/4"	8mm	10mm	12mm	1/2"
BGT90SRT	12.7	8	90°	L-RT	-	£31.00	-	-	-	-
BGT90SLRT	12.7	20	90°	L-RT	-	£33.00	-	-	-	-
BGT90RT	19	12	90°	L12-RT	£55.00	£55.00	£55.00	-	-	-
BGT90LRT	19	20	90°	L20-RT	-	-	£62.00	-	-	-
BGT90LKRT	19	30	90°	L30-RT	-	£64.00	£64.00	£64.00	£64.00	£64.00
BGT90LK2RT	19	50	90°	L50-RT	-	-	-	-	£69.00	£69.00
B19	Replacement bearing									£7.00

RT 90° Double Guided Trimmer

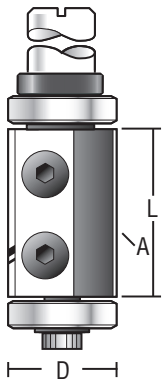

This cutter has a bearing mounted on the shank as well as on the bottom spigot.

BGT90LKDBRT



BG-TEST
145-002

Order Ref. No.	Dmm	Lmm	A	Tip	Shank		
					12mm	1/2"	
BGT90LKDBRT	19	30	90°	L30-RT	£89.00	£89.00	
BGT90LK2DBRT	19	50	90°	L50-RT	£95.00	£95.00	
B19	Replacement Bearing					£7.00	
B1912	Replacement Bearing					£7.00	

RT Ornamental Engraving Groove

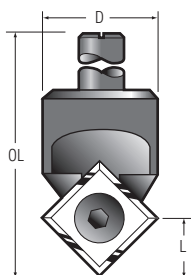

VGC45RT

n.max
24,000



Single flute, for cutting of inscriptions, ornamental grooves and engraving on CNC machines for use in solid wood and panel materials. Negative shear angle allows chip free cutting.

Order Ref. No.	Dmm	OLmm	Lmm	Cmm	Tip	TCT Shank	
						1/4"	1/2"
VGC45RT	17	58	8.3	12	L12-RT	£50.00	£50.00

Replacement Tip Chamfer

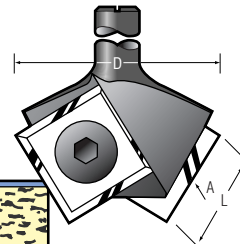

CT60RT

n.max
24,000

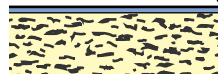

This series of Replacement Tip Cutters is a new edition to the Titman RT Range giving all angles required to produce bevels on Formica, melamine and top trimming PVC on small edge banding machines.

Order Ref. No.	Dmm	Lmm	A	Tip	TCT Shank		
					6mm	1/4"	8mm
CT22RT	32	12	22°	L12-RT	£49.00	£49.00	£49.00
CT45RT	25	12	45°	L12-RT	£49.00	£49.00	£49.00
CT60RT	24	12	60°	L12-RT	£49.00	£49.00	£49.00
CT80RT	22	12	80°	L12-RT	£49.00	£49.00	£49.00
CT90RT	23	12	90°	L12-RT	£49.00	£49.00	£49.00
L12	12x12x1.5mm Replacement tip						£3.00

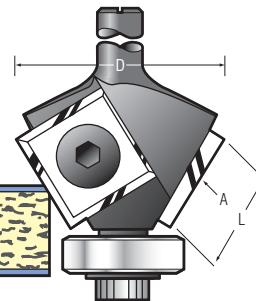

BGT80RT

n.max
24,000

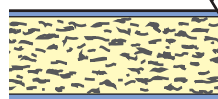

Replacement Tip Cutter with bearing. Safe for portable machines.

Order Ref. No.	Dmm	Lmm	A	Tip	Shank		
					6mm	1/4"	8mm
BGT80RT	22	12	80°	L12-RT	£55.00	£55.00	£55.00
BGT75RT	23	12	75°	L12-RT	-	-	£55.00
BGT60RT	28	12	60°	L12-RT	£55.00	£55.00	£55.00
BGT45RT	32	12	45°	L12-RT	£55.00	£55.00	£55.00
B16	Replacement bearing						£7.00
L12	12x12x1.5mm Replacement tip						£3.00
M4 x 6	Torx screws						£5.00
T15	Torx Screwdriver (yellow)						£5.00

RT Rounding & Chamfering

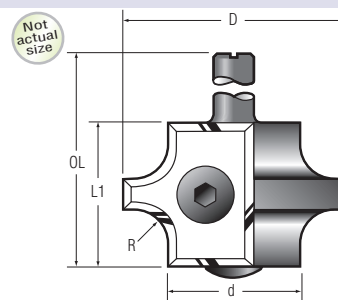

OC2-5RT

n.max
24,000



Rounding and chamfering of edge bands for use on solid wood and plastics.

Order Ref. No.	Dmm	d mm	L1mm	L2mm	Rmm	OLmm	TCT Shank	
							1/4"	1/2"
OC2-5RT	30.8	8	18.85	22	2-5	43	£93.00	£93.00
OCB2-5RT	30.8	8	18.85	22	2-5	43	£94.00	£94.00
RT-OC	Replacement tip					45° bevel	£11.00	
RT-OC2	Replacement tip					2	£10.00	
RT-OC3	Replacement tip					3	£10.00	
RT-OC4	Replacement tip					4	£10.00	
RT-OC5	Replacement tip					5	£10.00	

Please specify which tip you require when ordering. OCB is with bearing